

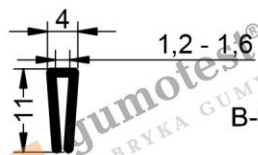

B-301

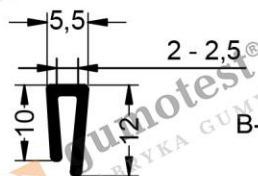

B-302



B-303

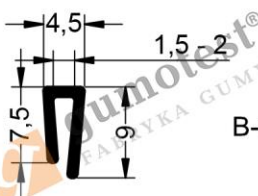

B-304

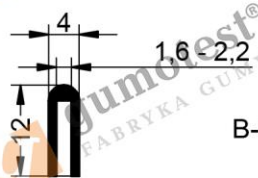

B-305

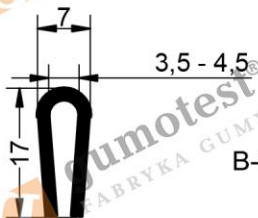

B-306

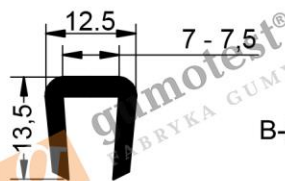

B-307

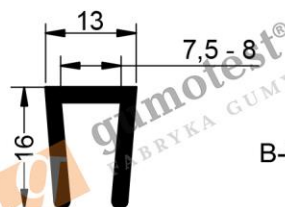

B-308

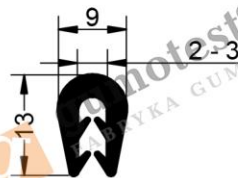

B-309

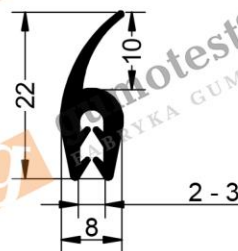

B-310

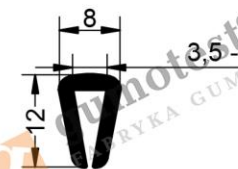

B-311

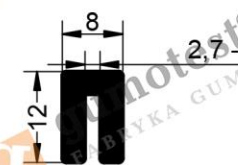

B-314

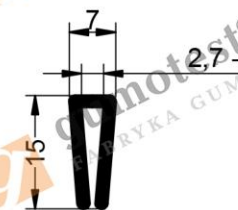

B-315

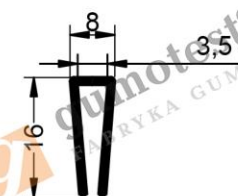

B-316

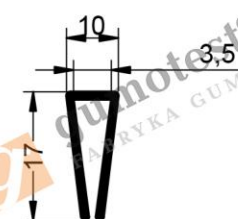

B-317

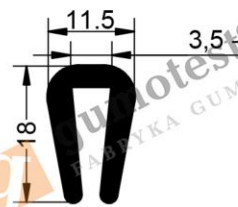

B-318



GUMOTEST Zbigniew Kawatek  
 Mazańcowice 57  
 43-365 Mazańcowice  
 Phone: +48 33 815-62-19  
 Website: www.gumotest.pl  
 E-mail: biuro@gumotest.pl

## Profile krawędziowe

Skala  
1:1

Nr rys.

1-01-01

Wersja

6.0

Data

05/03/2024

Format

A4

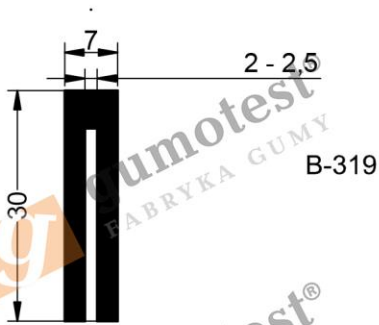

B-319

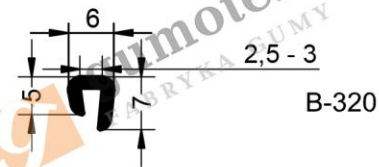

B-320



B-321



B-322

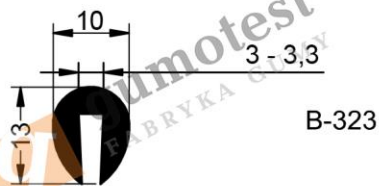

B-323

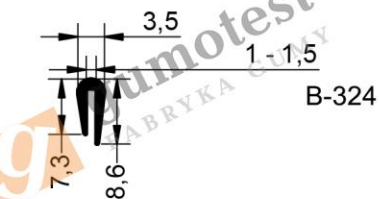

B-324

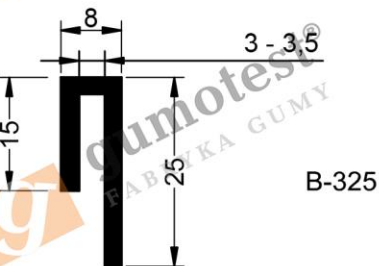

B-325

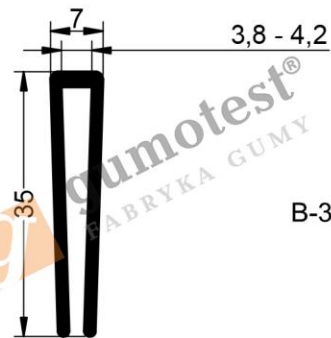

B-326

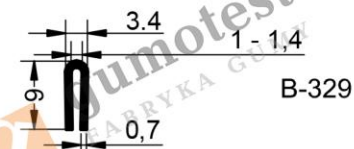

B-329



B-341

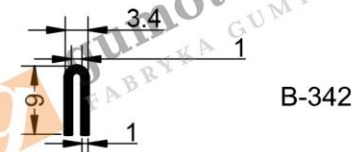

B-342



GUMOTEST Zbigniew Kawalek  
 Mazańcowice 57  
 43-365 Mazańcowice  
 Phone: +48 33 815-62-19  
 Website: www.gumotest.pl  
 E-mail: biuro@gumotest.pl

## Profile krawędziowe

Skala  
1:1

Nr rys.

1-01-01

Wersja

6.0

Data

05/03/2024

Format

A4